



**Aevo System™**  
**Ultrasound Dental Device**

**Instructions for Use**

## Contents

---

Intended Use	4	Power Adapter	13
Indications for Use	4	Ultrasound Coupling Gel Packets	14
Device Description	5	Mobile App (Optional)	15
Contraindications & Precautions	5	Device Operating Instructions	15
Warnings	6	Preparing for Treatment	15
Adverse Effects	9	Apply Ultrasound Gel to the Mouthpiece	16
Detailed Component Description	10	Inserting Mouthpiece into Mouth	18
Charging Case	12	Applying Treatment	20
Device	12	Pairing with Mobile App (Optional)	22

---

Troubleshooting	23	No Implied Warranties; Limitations on Damages	60
Device Status Indicator Description	25	Legal Limitations	61
Device Cleaning	27	Symbol Glossary	62
Charging the Battery	28	Contact	64
Care and Handling	32		
Technical Description	34		
Service Life	57		
Disposal	58		
Express Limited Warranty	58		

---

## Intended Use

---

The Aevo System™ enhances the physiological processes associated with orthodontic treatment. The Aevo System™ should be used for 20 minutes per day for maximum effect. Your dentist will instruct you on the correct usage and you will apply the daily treatment at home.

## Indications for Use

---

The Aevo System™ is used as an add-on to complement orthodontic braces (e.g., wire braces, clear aligners) and will not impact tooth movement unless the patient has orthodontic braces.

*Regular use of the Aevo System™ during orthodontic treatment will facilitate faster tooth movement, decrease orthodontically induced tooth root resorption, and shorten overall orthodontic treatment duration.*

The Aevo System™ should only be used by you.

## Device Description

---

The Aevo System™ is a medical device designed to provide low-intensity pulsed ultrasound (LIPUS) to a patient's dental area. The device is battery powered, portable, and intended for home use by orthodontic patients 12 years and older.

This document applies to the Aevo System™ model.

## Contraindications & Precautions

---

The effect of the Aevo System™ on active implantable devices (e.g., pacemakers, hearing aids, etc.) has not been evaluated. The operation of active implantable devices may be adversely affected by close exposure to the Aevo System™. Patients using an active implantable device should consult their doctor before use.

The safety and efficacy of the Aevo System™ has not been established in pregnant or nursing women or in children under the age of 12.

## Warnings

---

**CAUTION:** Use of controls or adjustments or performance of procedures other than those specified herein may result in hazardous exposure to ultrasonic energy or other hazardous situations. To reduce the risk of burns, electric shock, fire, injury, or damage to the equipment, it is important to note the following.

**CAUTION:** Do not attempt to modify, repair, or service any component or accessory of the Aevo System™. There are no user serviceable parts inside the device.

## Usage

The Aevo System™ is a single patient prescription device. It should only be used by you when prescribed by a dentist. Do not share your Aevo System™ device. Use of the device by more than one person may result in the transmission of viral and bacterial infective agents.

Do not use Aevo System™ if the new device was not received shrink wrapped in the Charging case.

Use only as directed. Do not exceed 20 minutes treatment per day. Do not grind your teeth on the mouthpiece or bite down with excessive force.

---

Do not abuse the Aevo System™. The Aevo System™ is a sophisticated electronic medical device. It is built to withstand normal use but cannot be abused. Abuse includes biting places other than the resting plate, chewing, twisting, or overly compressing under heavy weight.

Only use the ultrasound gel provided with the Aevo System™. Other ultrasound coupling gels available on the market are not designed or tested for use with the Aevo System™. Ensure that the ultrasound gel is not expired before use. If any adverse reaction to the gel occurs, contact your dentist.

Wireless communications equipment (e.g., wireless home network devices, cordless telephones and their base stations, walkie-talkies, etc.) can affect this equipment and should be kept at least 3.3 m away.

Do not use the Aevo System™ outside of the environmental conditions specified in this document.

## **Charging**

Do not attempt to charge the device with any other wireless inductive chargers. Only use the provided power supply adapter and charging case.

## **Storage**

Store the Aevo System™ in its charging case when not in use to avoid damage.

Avoid exposing the device to extreme heat or cold. Do not store outside the environmental conditions specified in this document.

Do not use the Aevo System™ immediately after storing the device at the minimum or maximum temperature specified in this document. It may take up to 1 hour before the device reaches room temperature and is ready for use.

## **Cleaning**

Do not clean any components or accessories in the dishwasher.

Do not attempt to use boiling, steaming, or dry heating to sterilize any components or accessories.



## **Damage**

Do not use the Aevo System™ if there are any signs of damage. This includes cracks, tears, or exposed electronic parts.

Do not touch or use the device if there is any evidence of battery leakage. Do not incinerate the Aevo System™ or its battery.

## **Adverse Effects**

---

Clinical evaluation for low-intensity pulsed ultrasound reported no significant adverse effects or medical complications.

Serious incidents are to be reported to the manufacturer and the competent authority.

In case of serious incident that has happened in relation to the Aevo System™, please report immediately to SmileSonica Inc.

## Detailed Component Description

---

A detailed component list for the Aevo System™ is shown in Figure 1.

Figure 1: Aevo System™ Detailed Component List

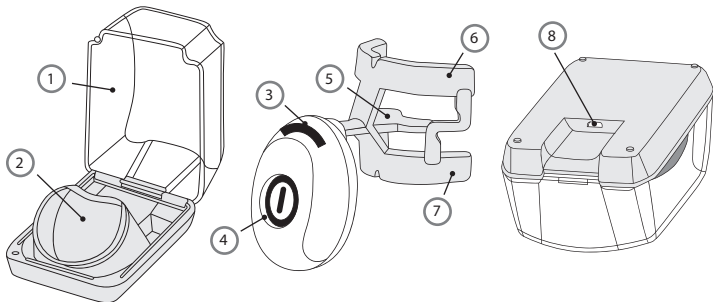

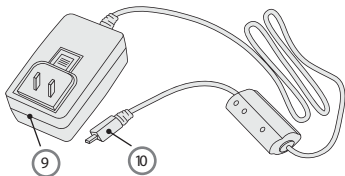

## Legend

1. Charging Case Lid
2. Charging Dock
3. Status Indicator
4. Power Button
5. Mouthpiece Resting Plate
6. Mouthpiece: Top (Maxilla) Arch
7. Mouthpiece: Bottom (Mandible) Arch
8. Charging Case Micro-USB Port
9. Power Adapter
10. Power Adapter Micro-USB Plug
11. Ultrasound Coupling Gel Packets <sup>a)</sup>

<sup>a)</sup> The ultrasound coupling gel is provided separately.

## **Charging Case (1, 2, 8)**

The charging case is used to store and charge the Aevo System™. It consists of a tray with a charging dock where the Aevo System™ is placed for both storage and charging and a lid that can be closed to cover the device. There is a micro-USB port on the bottom of the charging case where the power adapter must be plugged in to enable charging.

## **Device (3, 4, 5, 6, 7)**

The Aevo System™ device consists of a mouthpiece connected to electronics that sit just outside the mouth. The mouthpiece is covered in a biocompatible material that covers the ultrasound emitters. The mouthpiece is designed specifically to fit both the top (maxilla) and bottom (mandible) dental arch at the same time. The mouthpiece is flexible to accommodate various mouth sizes.

The mouthpiece delivers the treatment through the ultrasound gel and gums to the teeth roots, which are the intended treatment site. During treatment, place the mouthpiece in the mouth so the top and bottom fit over your gums and gently bite down on the resting plate.

The mouthpiece should only be placed inside your mouth once a day for a 20-minute treatment during the prescribed treatment period.

The electronics consists of a power button that is used to start treatment. It is powered by a rechargeable lithium polymer battery that can be recharged using the charging case. An LED and buzzer are used to indicate the device status. Bluetooth connectivity is also available for communication of the device status with the optional mobile app.

### **Power Adapter (9, 10)**

The power adapter's micro-USB plug connects to the charging case's micro-USB port to provide power to the charging case. The power adapter should not be used with any other device.

**WARNING:** Do not use any other power adapter outside the one specified in this document.

**NOTE:** The power adapter comes with the wall plug appropriate for the region of purchase.

Do not place the mouthpiece inside your mouth while the device is charging. Treatment cannot be activated while the Aevo System™ is charging.

## **Ultrasound Coupling Gel Packets (11)**

Ultrasound coupling gel is provided in single-use pouches. The gel is necessary for proper device functionality as it delivers ultrasound from the mouthpiece to the treatment area.

The entire packet of gel should be applied to the inside of the mouthpiece during every treatment.

## **Mobile App**

SmileSonica has developed a mobile app to allow you to track your treatment on your mobile device. The “Aevo System” mobile app is available in the App store for your phone.

The mobile app will display device information such as a treatment countdown timer and the battery charge level. As well, the mobile app will display your device usage history. The device usage history will also be visible by your dentist to encourage you to use the device every day.

The mobile app is compatible with mobile devices with Android 5.0 or iOS 9.0 or later versions.

The Aevo System™ will function with or without the mobile app.

## Device Operating Instructions

---

### Preparing for Treatment

Before using the Aevo System™, ensure you are in a location where you will be comfortable for the duration of the 20-minute treatment. Your mouth should be clean and free of food particles. Ensure that your orthodontic braces (e.g., wire braces, clear aligners) are placed in your mouth.

Visually inspect the Aevo System™. Check the device for any signs of damage prior to each use. If there is any damage, contact your local distributor or the manufacturer (if in Canada), and do not use the device. Damage to the mouthpiece could result in an increased risk of electric shock or choking.

Ensure the Aevo System™ is adequately charged prior to each treatment.

## Apply Ultrasound Gel to the Mouthpiece

**WARNING:** Before use ensure that the ultrasound gel is not expired and the gel pouch is not damaged. Only use the ultrasound gel provided with the Aevo System™. Other ultrasound coupling gels available on the market are not designed or tested for use with the Aevo System™. If any adverse reaction to the gel occurs, contact your dentist.

Before starting a treatment, tear open a corner of the gel pouch. All the gel from the pouch should be applied as a thin layer (3–4 mm thick) to the inside walls of the mouthpiece (see Figure 2). This ensures contact between the mouthpiece and your gums.

Do not swallow the gel. Rinse out your mouth with water after each treatment.



**NOTE:** Use the ultrasound gel during every treatment or the treatment may not be effective.

Important: Gel pouches are single use. This prevents contamination or infection. Store gel at room temperature between 15°C and 30°C. Expiry date format on gel pouches is YYYY-MM.

Figure 2: Applying Ultrasound Gel to the Mouthpiece

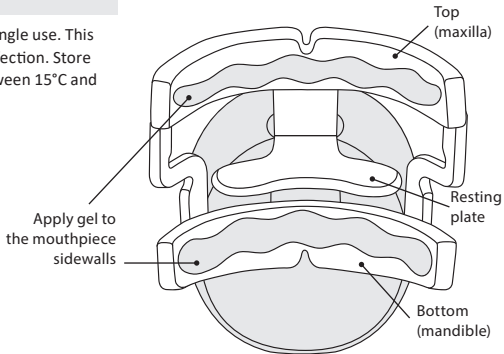

## Inserting Mouthpiece into Mouth

Place the mouthpiece into your mouth, (see Figure 3) in the same manner as a mouthguard. The mouthpiece is flexible and can be adjusted when placing it in your mouth. The top (maxilla) and bottom (mandible) should fit directly on the corresponding dental arch and gently rest your teeth on the resting plate. The mouthpiece should be positioned over your gums and orthodontic braces (e.g., wire braces, clear aligners). To get comfortable with the process, you can practice inserting the mouthpiece into your mouth without ultrasound gel a couple times prior to your first treatment.

**NOTE:** You may experience increased salivation and temporary pressure points on the gums when first using the Aevo System™. This should decrease over time.

**WARNING:** Do not grind your teeth on the mouthpiece or bite down with excessive force.

**REMINDER:** Whenever you remove the mouthpiece from your mouth during treatment, it should be cleaned, rinsed, and coated with new ultrasound gel before it is placed back in your mouth.

Figure 3: Placing Mouthpiece in Mouth

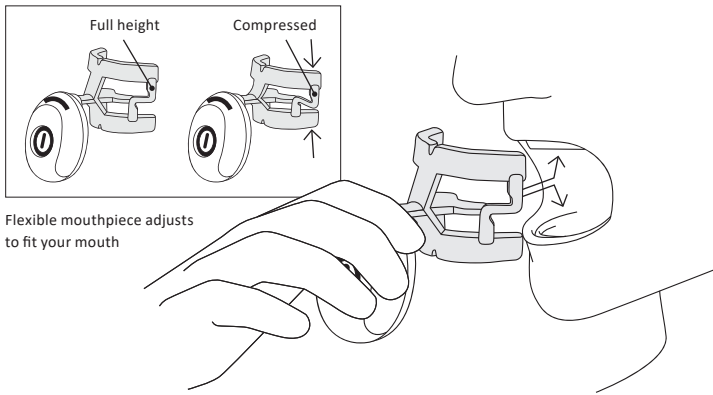

## Applying Treatment

### 1. Turning On Device

Press the power button ① to turn on the device. The status indicator will turn solid green when the device is ready for treatment.

### 2. Starting Treatment

Press the power button ① again to start treatment. The status indicator will turn solid blue when treatment starts. It will remain on for the duration of the 20-minute treatment.

**NOTE:** Prior to starting treatment, the device performs a self-diagnosis. If either the top or bottom is outside of tolerance, the treatment will not proceed. If the status indicator shows any other colour than blue when attempting to start treatment, please refer to the Troubleshooting section.

### 3. Pausing Treatment

Press the power button ① to pause the treatment. The status indicator will start blinking blue and the treatment will remain paused for up to 10-minutes. To resume a paused treatment, press the power button ①.

After being paused for 10-minutes, the device will turn off and any treatment progress will be lost.

**REMINDER:** If you remove the mouthpiece from your mouth while treatment is paused, it should be cleaned, rinsed, and coated with new ultrasound gel before it is placed back in your mouth.

### 4. Finishing Treatment

Once the 20 minutes treatment time elapses, the Aevo System™ automatically stops the treatment and the status indicator will turn off. Remove the mouthpiece from your mouth, spit out any excess ultrasound gel, and rinse your mouth with water.

**NOTE:** Maintenance or testing of the device is not needed.

**NOTE:** The Aevo System™ is only intended to be used for 20 minutes per day. To discourage overuse, the device will only allow a new treatment to be started 1 hour after the last treatment finished.

## 5. Turning Off Device

Once treatment is complete, the Aevo System™ will automatically turn off. If you need to turn off the Aevo System™ while it is on, press and hold the power button  for 2 seconds.

If treatment is not active, the device will automatically turn off after 10 minutes. If turned off while a treatment is paused, treatment progress will be lost.

## Pairing with Mobile App (Optional)

Prior to pairing, enable Bluetooth on your mobile device. With the device turned off, press and hold the power button  for 5 seconds to enable pairing mode. The status indicator will slowly blink purple to indicate that the device is in pairing mode. The mobile app will prompt you to follow the steps to pair your Aevo System™ device with your mobile device. Once successfully paired to your mobile device, the status indicator will quickly blink purple for 2 seconds.

## Troubleshooting

---

Issue	Action
Device (mouthpiece or electronics), charging case, or power adapter physically damaged (e.g., cracks, cuts, holes, visible internal parts, etc.)	Do not use the device. Contact your local distributor or the manufacturer (if in Canada).
Try to turn on device but no status indicator comes on	Fully charge the battery. If the problem persists, contact your local distributor or the manufacturer (if in Canada).
Adverse reaction to the ultrasound gel or any other health problem during the treatment	Do not use the device. Contact your dentist.
Battery leaks or does not recharge	Do not use the device. Contact your local distributor or the manufacturer (if in Canada).

Issue	Action
Insufficient ultrasound gel	Do not use the device. Contact your dentist to obtain more ultrasound gel.
Blinking yellow status indicator	See Device Status Indicator Description section. If the problem persists, contact your local distributor or the manufacturer (if in Canada).
Solid yellow status indicator while trying to start treatment	Wait until at least one hour has elapsed since your last treatment was completed. If the problem persists, contact your local distributor or the manufacturer (if in Canada).
Mouthpiece gets too hot during treatment	Do not use the device. contact your local distributor or the manufacturer (if in Canada).
Any other failure in operation as intended	Turn the device off and back on again. If the problem persists, contact your local distributor or the manufacturer (if in Canada).



## Device Status Indicator Description

---

Description	Status
Solid green plus short beep	Device ready for treatment
Solid blue plus short beep	Treatment active
Blinking blue plus short beep	Treatment paused
Blinking orange continuously	Battery charging
Blinking orange for 3 seconds plus short beep	Low battery
Blinking yellow (2 blinks) plus short beep	Maximum number of treatments reached

---

Description	Status
Blinking yellow (3 blinks) plus short beep	Mouthpiece not functional
Blinking yellow (4 blinks) plus short beeps	Device incorrectly placed in charging case
Solid yellow for 5 seconds plus short beep	Treatment attempted during 1-hour period after last treatment
Slow blinking purple for 1 minute or until device is connected (whichever occurs first)	Device in Bluetooth pairing mode
Rapid blinking purple for 2 seconds followed by solid purple for 2 seconds plus short beep	Bluetooth pairing successful

## Device Cleaning

---

The device should be cleaned after each use to maintain the Aevo System™.

Proper cleaning will remove contamination and prevent infection. Additionally, regular cleaning of the charging case is recommended.

**WARNING:** Do not clean any component of the Aevo System™ in a dishwasher or other household appliance. Do not use cleaning agents or solvents (including mouthwash or alcohol) on any of the components of the Aevo System™. Do not clean the mouthpiece with hot or boiling water. Do not use a heat source to dry the mouthpiece. Do not sterilize the Aevo System™. Do not immerse the charging case or power adapter in water or any other liquid.

The Aevo System™ should only be cleaned using the following procedure.

1. Rinse off the ultrasound gel from the mouthpiece of the device with cold, flowing tap water.

**NOTE:** Cold water will help rinse off the gel more easily.

2. Add three drops of dishwashing liquid to a wetted, soft-bristle manual toothbrush. Use the toothbrush to lightly clean all surfaces of the mouthpiece for a minimum of two minutes.

3. Ensure all surfaces are clean before rinsing off the mouthpiece with cold, flowing tap water.
4. Use a clean soft cloth, paper towel, or cotton swab to clean the device enclosure and the surface of the charging case that holds the mouthpiece. Keep the charging case dry before using or storing.
5. Let the mouthpiece air dry at room temperature while stored in the charging case.

## Charging the Battery

---

Keep your device battery charged so that a full treatment can be completed. You may charge the battery anytime it is not being used for treatment, as treatment cannot be activated while the device is charging. When the status indicator indicates a low battery, charge the device until the battery is fully charged.

**NOTE:** The battery will take approximately 5 hours to completely charge.

**WARNING:** Do not place the mouthpiece in your mouth while charging. Only charge the Aevo System™ with the provided power adapter.

**NOTE:** The power adapter comes with the wall plug appropriate for the region of purchase.

To charge the device battery, use the following steps.

1. Visually inspect the charging case and power adapter for signs of damage. If there is any damage, contact your local distributor or the manufacturer (if in Canada) and do not attempt to continue charging the device.
2. Plug the power adapter into the charging case.
3. Plug the power adapter into an electrical outlet.
4. Dock the device on the charging case to begin charging. If placed incorrectly, the status indicator will blink yellow and the device will beep until removed and placed correctly.
5. The status indicator will blink orange while the device is charging. Once the battery is fully charged, the status indicator will turn off.

**NOTE:** To keep the battery fully charged, you may keep your Aevo System™ in the charger when not in use.

**Figure 4: Charging the Battery**

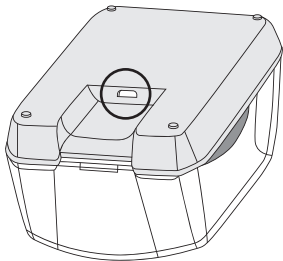

**1. Connect the power adapter to the charging case.**

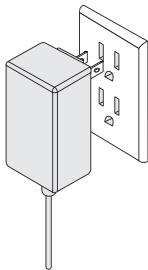

**2. Connect the power adapter to an electrical outlet.**

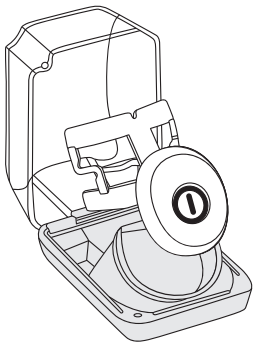

3. Dock the device on the charging case.

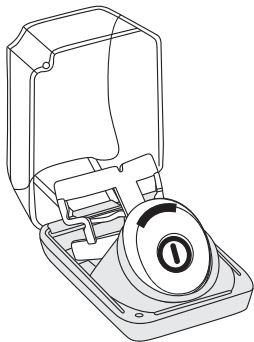

4. Blinking orange status indicator while device charging. Status indicator turned

## Care and Handling

---

The Aevo System™ contains complex electronic and ultrasonic technology and should be handled with care. In order to avoid possible damage, it is important to note the following.

### Storage

Place the device in the charging case and store in a clean and dry environment including the power adapter. It should be stored at temperature specified in this document. If the device is being stored for more than three months, the battery should be fully charged prior to storage and the charging case should be unplugged.

### Temperature

The Aevo System™ should be operated only within the specified operating temperatures (10°C to 25°C) and protected from extreme heat or cold. If it is stored or transported in temperatures outside this range, allow the device to return to the operating temperature range before use.



## Cleaning

The Aevo System™ is only used by a single patient so disinfection of the mouthpiece is not required. Only clean the device and charging case as described in this document.

## Damage

Protect the Aevo System™ from impact, exposure to moisture outside the range specified in this document, liquid spills, sand, dirt, or debris. Avoid bending or stretching the mouthpiece more than is required to place it in your mouth. Excessive force can cause internal damage to the mouthpiece. This damage is not covered by the product warranty.

Before each treatment, inspect the mouthpiece for cracks or signs of damage. If there are any cracks or damage, contact your local distributor or the manufacturer (if in Canada) and do not use the device. Do not attempt to modify or repair the Aevo System™, as there are no user-serviceable parts inside the device.

## Technical Description

---

The following is a technical description for the Aevo System™. This information provides environmental operating conditions, transport and storage conditions, and IEC 60601 equipment ratings and electrical safety classification for the Aevo System™. The Aevo System™ has been designed and tested to operate under the following conditions.

**WARNING:** No modification of this equipment is allowed.

### Environmental Operating Conditions

Temperature range: 10°C – 25°C

Relative humidity range: 15% – 90%, non-condensing

Atmospheric pressure range: 700 hPa – 1060 hPa

## Transport and Storage Conditions

Temperature range: -20°C – 40°C

Maximum relative humidity: 95%, non-condensing

## Power Adapter

Input: 100 – 240 Vac, 50 – 60 Hz

Output: 5 Vdc, >0.5 A

**NOTE:** The device is also internally powered by a rechargeable lithium polymer battery.

## Ultrasound Technical Specifications

The Aevo System™ ultrasound parameters are shown below. Neither the dentist nor the patient can select or change any of the Aevo System™ ultrasound parameters. The Aevo System™ mouthpiece consists of an array of 16 transducers, with 8 transducers on the top (maxilla) and 8 transducers on the bottom (mandible).

Table 1: Aevo System™ Ultrasound Parameters

Parameter	Parameter Value
Ultrasonic frequency	1.5 ± 5% MHz
Intensity ratio (TM/TA)	5
Spatial average-temporal average (SATA) intensity	30 ± 30% mW/cm <sup>2</sup>
Spatial average-temporal maximum (SATM) intensity	150 ± 30% mW/cm <sup>2</sup>
Waveform	Amplitude Modulated 
Pulse duration	200 ± 5% μs
Pulse repetition rate	1.0 ± 5% kHz

Parameter		Parameter Value
Effective radiating area (ERA)	Top (Maxilla)	3.98 ± 20% cm <sup>2</sup>
	Bottom (Mandible)	4.00 ± 20% cm <sup>2</sup>
Maximum beam non-uniformity ratio (BNR)		7.9
Type of applicator		Diverging

## Device Classification



Type BF Applied Part



Electrical Protection Class: Class II Equipment

## Ingress Protection

The device is classified as IP35, which means that it is protected against access to hazardous parts with solid objects greater than 2.5 mm<sup>2</sup> and protected against the effect of low-pressure water jets (all directions).

The charging case is classified as IP32, which means that it is protected against access to hazardous parts with solid objects greater than 2.5 mm<sup>2</sup> and protected against dripping water when tilted up to 15° from vertical.

**WARNING:** To prevent damage or risk of electric shock, do not immerse the charging case or power adapter in water or any other liquid.

## EMC Requirements

As per IEC 60601-1-2:2014 section 5.2.1.1, the Aevo System™ is intended for use in the home healthcare environment including domiciles (residences, homes, nursing homes), hotels, hostels, and pensions. The home healthcare environment excludes vehicles (cars, buses, trains, boats, planes, and helicopters), train stations, bus stations, airports and outdoors (streets, sidewalks, and parks). The user of the Aevo System™ should ensure that it is used in such an environment.

Aevo System™ needs special precautions regarding EMC and needs to be used according to the EMC guidance and warnings provided in this section.

**WARNING:** The Aevo System™ is equipped with a power adapter which is used as part of the Aevo System™ and complies with IEC 60601-1-2:2014. Use of cables or accessories other than those specified, except cables and accessories sold by the manufacturer of Aevo System™ as replacement parts for internal components, may result in increased emissions or decreased immunity of Aevo System™.

**WARNING:** Portable RF communications equipment (including peripherals such as antenna cables and external antennas) should be used no closer than 30 cm (12 inches) to any part of the Aevo System™, including the power adapter cable. Otherwise, degradation of the performance of this equipment could result.

**WARNING:** Use of this equipment adjacent to or stacked with other equipment should be avoided because it could result in improper operation. If such use is necessary, this equipment and the other equipment should be observed to verify that they are operating normally.

## 1. Essential Performance

The Aevo System™ has been designed to ensure that:

- a) The ultrasound intensity output will not exceed  $3 \text{ W/cm}^2$ .
- b) The mouthpiece surface temperature will not exceed  $43^\circ\text{C}$  under normal use conditions.

The Aevo System™ has been tested to be in compliance with IEC 60601-1-2:2014 and maintains its essential performance regardless of electromagnetic disturbances.

If the essential performance is lost or degraded due to electromagnetic disturbances, the mouthpiece surface temperature may exceed  $43^\circ\text{C}$ . If this happens, stop using the Aevo System™.

## 2. Bluetooth

The Aevo System™ implements Bluetooth Low Energy (BLE) technology to connect to the optional mobile app.



Table 2: Aevo System™ Bluetooth Parameters

Parameter	Specification
Operating Frequency Range	2402 – 2480 MHz
Channels	40
Channel separation	2 MHz
Modulation	Gaussian Frequency Shift Keying (GFSK)
Effective Radiated Power (ERP)	+3 dBm

### 3. Inductive Charging

The Aevo System™ implements inductive charging technology to charge the device internal battery. The Aevo System™ transmits and receives electromagnetic energy at 110 – 205 kHz for the purposes of inductive charging.

### 4. EMC Compliance Statement

#### 4.1 FCC

This device complies with Part 15 of the FCC Rules. Operation is subject to the following two conditions:

- a) This device may not cause harmful interference, and
- b) This device must accept any interference received, including interference that may cause undesired operation.

**NOTE:** This equipment has been tested and found to comply with the limits for a Class B digital device, pursuant to Part 15 of the FCC Rules. These limits are designed to provide reasonable protection against harmful interference in a residential installation. This equipment generates, uses and can radiate radio frequency energy and, if not installed and used in accordance with the instructions, may cause harmful interference to radio communications. However, there is no guarantee that interference will not occur in a particular installation.

If this equipment does cause harmful interference to radio or television reception, which can be determined by turning the equipment off and on, the user is encouraged to try to correct the interference by one or more of the following measures:

- Reorient or relocate the receiving antenna.
- Increase the separation between the equipment and receiver.
- Connect the equipment into an outlet on a circuit different from that to which the receiver is connected.
- Consult the dealer or an experienced radio/TV technician for help.

This device also complies with Part 18 of the FCC Rules.

#### 4.2 CAN ICES-3(B)/NMB-3(B), CAN ICES-1/NMB-1, CAN RSS-216/CNR-216

This device complies with Industry Canada's license-exempt RSSs.

Operation is subject to the following two conditions:

- a) This device may not cause interference; and
- b) This device must accept any interference, including interference that may cause undesired operation of the device

#### 5. Electromagnetic Emissions

The Aevo System™ is intended for use in the electromagnetic environment specified below. The customer or user of the Aevo System™ should ensure that it is used in such an environment.

Table 3: Guidance and Manufacturer's Declaration – Electromagnetic Emissions

Emissions Test	Compliance Class	Electromagnetic environment - guidance
Radiated RF emissions CISPR 11	Group 1 Class B	The Aevo System™ uses RF energy for its internal functions which are unlikely to cause any interference in the nearby electronic environment.
Conducted RF emissions CISPR 11	Group 1 Class B	The Aevo System™ is suitable for connection to the public low-voltage AC mains network that supplies home healthcare environments specified in this document.
Harmonic current emissions IEC 61000-3-2	Class A	
Voltage fluctuations/flicker emissions IEC 61000-3-3	Complies	

## 6. Electromagnetic Immunity

The Aevo System™ is intended for use in the electromagnetic environment specified below. The customer or user of the Aevo System™ should ensure that it is used in such an environment.

Table 4: Guidance and Manufacturer's Declaration – Electromagnetic Immunity

Immunity Test	IEC 60601 test level	Minimum Performance Criteria	Electromagnetic environment - guidance
Electrostatic discharge (ESD) IEC 61000-4-2	Contact discharge: ±8 kV Air discharge: ±2, ±4, ±8, ±15 kV	C	Floors should be wood, concrete or ceramic tile. If floors are covered with synthetic material, the relative humidity should be at least 30%.

Immunity Test	IEC 60601 test level	Minimum Performance Criteria	Electromagnetic environment - guidance
Electrical fast transient/burst IEC 61000-4-4	Input AC mains port: $\pm 0.5, \pm 1, \pm 2$ kV	B	The quality of AC mains supply should be equivalent to a typical home healthcare environment as specified in this document.
Surge IEC 61000-4-5	Line-to-line: $\pm 0.5, \pm 1$ kV differential mode	B	The quality of AC mains supply should be equivalent to a typical home healthcare environment as specified in this document.

Immunity Test	IEC 60601 test level	Minimum Performance Criteria	Electromagnetic environment - guidance
Voltage dips IEC 61000-4-11	0 % $U_T$ for 0.5 cycle At 0°, 45°, 90°, 135°, 180°, 225°, 270° and 315°	B	The quality of AC mains supply should be equivalent to a typical home healthcare environment as specified in this document. During interruption, the internal battery will continue to power the device.
	0 % $U_T$ for 1 cycle and 70 % $U_T$ for 25/30 cycles At single phase: 0°	B	
Voltage interruptions IEC 61000-4-11	0 % $U_T$ for 250/300 cycles	C	



Immunity Test	IEC 60601 test level	Minimum Performance Criteria	Electromagnetic environment - guidance
Power frequency magnetic field IEC 61000-4-8	30 A/m 50 Hz or 60 Hz	A	The Aevo System™ should not be affected by power frequency magnetic fields levels in a typical home healthcare environment. Immunity levels are based on a 15 cm separation distance from the source.

**NOTE:**  $U_T$  is the AC mains nominal voltage prior to application of the test level.

The minimum performance criteria are defined as follows:

A: Performance within specification limits (i.e., no disruption of essential performance)

B: Temporary degradation which is self recoverable.

C: Temporary degradation which requires operator intervention.

D: Loss of function which is not recoverable.

Table 5: Guidance and Manufacturer's Declaration – Electromagnetic Immunity

Immunity Test	IEC 60601 test level	Minimum Performance Criteria	Electromagnetic environment - guidance
Conducted RF IEC 61000-4-6	150 kHz - 80 MHz: 3 Vrms  ISM and amateur radio bands between 0.15 MHz and 80 MHz: 6 Vrms  80 % AM at 1 kHz	A	The quality of AC mains supply should be equivalent to a typical home healthcare environment as specified in this document.

Immunity Test	IEC 60601 test level	Minimum Performance Criteria	Electromagnetic environment - guidance
Radiated RF IEC 61000-4-3	10 V/m 80 MHz – 2.7 GHz 80 % AM at 1 kHz	A	The Aevo System™ was tested to withstand up to 10 V/m of radiated RF disturbances. To avoid degradation in performance of the Aevo System™, keep at least 30 cm away from other electronic devices when in use.

Immunity Test	IEC 60601 test level	Minimum Performance Criteria	Electromagnetic environment - guidance
Proximity fields from RF wireless communications equipment  IEC 61000-4-3	See Table 4	A	<p>The Aevo System™ was tested to be compatible within the proximity of common home healthcare environment RF communication services as listed in Table 6.</p> <p>The services listed in Table 6 are not exhaustive as interference can still occur when used within the proximity of unaccounted services. To reduce chances of interference, do not use Aevo System™ within 30 cm of any wireless communication equipment.</p>

The minimum performance criteria are defined as follows:

A: Performance within specification limits (i.e., no disruption of essential performance)

B: Temporary degradation which is self recoverable.

C: Temporary degradation which requires operator intervention.

D: Loss of function which is not recoverable.

The ISM (industrial, scientific and medical) bands between 0.15 MHz and 80 MHz are 6.765 MHz to 6.795 MHz; 13.553 MHz to 13.567 MHz; 26.957 MHz to 27.283 MHz; and 40.66 MHz to 40.70 MHz.

The amateur radio bands between 0.15 MHz and 80 MHz are 1.8 MHz to 2.0 MHz, 3.5 MHz to 4.0 MHz, 5.3 MHz to 5.4 MHz, 7 MHz to 7.3 MHz, 10.1 MHz to 10.15 MHz, 14 MHz to 14.2 MHz, 18.07 MHz to 18.17 MHz, 21.0 MHz to 21.4 MHz, 24.89 MHz to 24.99 MHz, 28.0 MHz to 29.7 MHz, and 50.0 MHz to 54.0 MHz.

**Table 6: Guidance and Manufacturer’s Declaration – Proximity fields from RF wireless communications equipment**

Test Frequency (MHz)	Band (MHz)	Service
385	380 – 390	TETRA 400
450	430 – 470	GMRS 460, FRS 460
710, 745, 780	704 – 787	LTE Band 13, 17
810, 870, 930	800 – 960	GSM 800/900, TETRA 800, iDEN 820, CDMA 850, LTE Band 5
1720, 1845, 1970	1700 to 1990	GSM 1800; CDMA 1900; GSM 1900; DECT; LTE Band 1, 3, 4, 25; UMTS

Modulation	Maximum Power (W)	Separation Distance (m)	Immunity Test Level (V/m)
Pulse modulation 18 Hz	1.8	0.3	27
FM ± 5 kHz deviation 1 kHz sine	2	0.3	28
Pulse modulation 217 Hz	0.2	0.3	9
Pulse modulation 18 Hz	2	0.3	28
Pulse modulation 217 Hz	2	0.3	28

Test Frequency (MHz)	Band (MHz)	Service
2450	2400 to 2570	Bluetooth, WLAN, 802.11 b/g/n, RFID 2450, LTE Band 7

**NOTE:** Test procedure is based on IEC 61000-4-3. The minimum separation distance is 30 cm.



Modulation	Maximum Power (W)	Separation Distance (m)	Immunity Test Level (V/m)
Pulse modulation 217 Hz	2	0.3	28

## Service Life

---

The Aevo System™ should last for up to two years of continuous use if used with care and within the ranges recommended in this document.

## Disposal

---

Contact your local waste disposal centre to dispose of the Aevo System™ as you would other electronics.

## Express Limited Warranty

---

SmileSonica Inc. (“SmileSonica”) warrants that the product (the “Product”) packaged with this warranty will be free from significant defects in materials and workmanship under normal use and service for a period of one year from the date of purchase (the “Warranty Period”). This limited warranty is non-transferable and applies only to the original purchaser and his or her initial dental patient using the Product. This limited warranty also applies only when the Product is used in accordance with the Product manual and directions for use packaged with this Product.

This limited warranty covers all defects encountered in normal use and service but does not apply if: (1) the Product is modified or tampered with or disassembled, (2) the Product is damaged by an Act of God, misuse, abuse, neglect, accident, or mishandling, (3) the Product is not used or maintained in accordance with the accompanying user documents, (4) the Product is repaired by someone other than an authorized service centre, or (5) the serial number on the Product is defaced, altered, or removed.

In addition, this limited warranty does not cover normal wear such as discoloration or fading and normal wear that does not compromise use of the appliance such as chips, scratches, and abrasions. Your exclusive remedy for breach of this limited warranty during the Warranty Period shall be, at the option of SmileSonica, the repair or replacement of the Product (with new or comparable rebuilt parts) or a new or refurbished Product, as determined by SmileSonica. Warranty repair or replacement shall not extend the original Warranty Period.

All returns for warranty service will require an RMA (Return Merchandise Authorization). To receive an RMA for obtaining warranty services, you must contact your local distributor or the manufacturer (if in Canada).

In addition, if the Product has not been registered you must submit proof of the date of original purchase such as a copy of your dated invoice and must insure, pack and ship the Product to an authorized service centre in accordance with the provided instructions within 7 days after your receipt of an RMA. The packing must include your RMA. RMA's will not be extended or reissued.

## **No Implied Warranties; Limitations on Damages**

---

The express limited warranty provided above is the only express warranty made to you and is in lieu of all other warranties, whether express or implied. Without limiting the generality of the foregoing, SmileSonica Inc. disclaims any and all other warranties, express or implied, with respect to the product, including its condition, the existence of any latent or patent defects, its non-infringement of third-party rights, and its merchantability or fitness for any particular use.

In no event shall SmileSonica Inc. or any of its affiliated or subsidiary companies be liable for any special, incidental, or consequential damages based upon breach of warranty, breach of contract, negligence, tort, or any other legal theory. Such damages include, without limitation: loss of savings or revenue; loss of profit; loss of use; the claims of third parties, including, without limitation, dental professionals; and cost of any substitute equipment or services.

## **Legal Limitations**

---

Some jurisdictions do not permit or allow limitations on how long implied warranties last or the exclusion or limitation of incidental or consequential damages. If any terms of this limited warranty, including, without limitation, the exclusion of damages, are limited or prohibited by your jurisdiction, the prohibited provision shall not apply but the remainder of this limited warranty shall remain in full force and effect. You may have rights in addition to this limited warranty under the laws of your jurisdiction, which may vary from jurisdiction to jurisdiction.

## Symbol Glossary

---



Manufacturer



Date of Manufacture



Country of Manufacture



Type BF applied part



Amplitude modulated waveform



Single Patient Multiple Use



Part number



Refer to instructions for use



Caution: Ultrasound



Single use only



Lot number



Medical device



Federal Communications Commission



Expiration date



Start (push/hold)



Class II equipment



Serial number



Keep Dry



Fragile, handle with care



Separate collection for  
waste electrical and  
electronic equipment

**RxOnly**

Caution: Federal law restricts  
this device to sale by or on the  
order of a physician or dentist



CE Mark



European Community  
Representative



Temperature limitation



Unique Device Identifier

## Contact

---

Visit [aevosystem.com](http://aevosystem.com) to learn more. If you have any questions, comments, or concerns, please contact SmileSonica at the address below.



**SmileSonica Inc.**

11514 – 168 Street NW  
Edmonton, Alberta, Canada T5M 3T9

P: +1.587.758.8433

TF: 1.855.758.8433

E: [questions@aevosystem.com](mailto:questions@aevosystem.com)



[www.aevosystem.com/instructions-for-use](http://www.aevosystem.com/instructions-for-use)

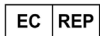

Emergo Europe B.V.  
Westervoortsedijk 60  
6827 AT, Arnhem  
The Netherlands

